

LOCKED AND LOADED CONVERSION KIT

LOCKED AND LOADED

**OPERATION & SERVICE MANUAL
MODEL NUMBERS: 1US95-01 & 1US95-02**

366-0129-01

**DATA EAST USA INC
260 Elk Grove Village, IL 60007**

LOCKED AND LOADED CONVERSION KIT

1995 by DATA EAST USA INC Corporation
ALL RIGHTS RESERVED

No part of this publication may be reproduced by any mechanical, photographic or electronic process, or in the form of a phonographic recording, nor may it be stored in a retrieval system, transmitted or otherwise copied for public or private use, without permission from the publisher.

The game play, all graphic design, this technical manual, its accompanying wiring diagrams and the display manual are protected by the U.S. Copyright Act of 1976.

This Act provides for substantial penalties for violating federal copyright laws. Courts can impound infringing articles while legal action is pending. If infringers are convicted courts can order destruction of the infringing articles.

In addition, the Act provides for payment of statutory damages of up to \$50,000 per infringing transactions in certain cases. Infringers may also have to pay cost and attorneys' fees and face imprisonment of up to five years as well as fines of up to \$250,000 in the case of individuals and up to \$500,000 in the case of corporations.

DATA EAST USA INC, will aggressively enforce its copyrights against infringers. We will use all legal means to immediately halt any manufacture, distribution, or operation of a copy of any games made by us. Anyone who purchases such copies risks forfeiting such a game.

Published by:
DATA EAST USA INC
260 Stanley Street
Elk Grove Village, IL 60007
Tel: 708 - 290 -0090

Printed in the U.S.A. Produced by Data East Technical Publications Department.

LOCKED AND LOADED CONVERSION KIT

WARRANTY INFORMATION

DATA EAST USA INC, (Seller"), warrants to the original purchaser ("Buyer"), of its products that the items listed below are free from defects in material and workmanship under normal use and service for the period specified:

GAME LOGIC PRINTED CIRCUIT BOARD(S): 90 DAYS

No other parts of the Seller's products are warranted.

Warranty periods are effective from the date of original shipment from Seller to Buyer. Seller's sole liability shall be, at its option, to repair or replace products which are returned to Seller during the warranty period specified, provided:

1. Seller is notified promptly upon discovery by Buyer that the stated products are defective.
2. Buyer obtains a valid return material authorization (RMA) number from Seller.
3. Such products are properly packed and then returned freight prepaid, to a place specified by Seller.

This warranty does not apply to products damaged during shipment and / or due to improper installation or usage, or alteration. In no event shall Seller be liable for any anticipated profits, loss of profits, loss of use, accidental or consequential damages, or any other losses incurred by the customer in connection with the purchase of a DATA EAST USA INC, product.

Except as specifically provided in a written contract between Seller and Buyer, there are no other warranties expressed or implied, including any implied warranties of merchantability or fitness for a particular purpose.

LOCKED AND LOADED CONVERSION KIT

TABLE OF CONTENTS

Installations

Specific Requirements.....	1
List of Materials.....	1-2
Installation Instructions.....	3-5

Game Information

Operator Options.....	6- 8
Adjustments.....	9-10

Wiring Diagrams / Schematics

Jamma Connector	11
Gun Information	12-13
Conversion Adaptors	14
Audio - Video Output Schematic	15
Coin Counter Schematic	16

SPECIFIC REQUIREMENTS:

Thank you for purchasing a Data East game. We hope that it will give you many years of profitable enjoyment. Your LOCKED AND LOADED game conversion kit is intended to be installed into an existing gun video game cabinet and comes with all the necessary components to make the converted unit look and play like a new, dedicated game.

WARNING

The game to be converted must meet the following requirements:

AC INPUT: 110 - 120 Vac / 60 Hz

MONITOR: Horizontal, RGB, Negative Sync Input

POWER SUPPLY: + 5Vdc, (+,- 2%) 11 Amp.
+12 Vdc, (+,- 2 %) 2 Amp.

Make sure that an ISOLATION TRANSFORMER is used between the incoming Ac and the Monitor.

LIST OF MATERIALS:

Locked and Loaded Kit , Model Number 1US95-01
Part Number: 570-0074-00

Qty:	Description	Part Number
1	Installation and Service Manual	366-0129-01
1	PCB, Locked and Loaded	520-0164-00
1	Adaptor, Conversion, Gun, L&L	036-5311-00
1	Sound adaptor Harness	036-5311-01
1	Harness, With Test Switch, L&L	036-5311-03
2	Decal, Left & Right, Side Cabinet, L&L	820-0084-00
1	Marquee Header, Locked and Loaded	830-0065-01
1	Monitor Underlay Card, Weapons	810-0063-00
1	Decal, Player 1 Start, Blue	406-0512-03
1	Decal, Player 2 Start, Red	406-0512-04
1	Control panel overlay	406-0512-05

LOCKED AND LOADED CONVERSION KIT

2

LIST OF MATERIALS:

Locked and Loaded Kit, Model Number 1US95-02

Part Number: 570-0074-01

Qty:	Descriptions	Part Number
1	Installation and Service Manual	366-0129-01
1	PCB, Locked and Loaded	520-0164-00
1	Complete Harness Ac, Dc, Jamma, L&L	036-5311-02
1	Harness, With Test Switch, L&L	036-5311-03
2	Gun Assy (Happ), Orange, W/Harness	515-0169-01
2	Holster, Gun, Locked and Loaded	515-0169-03
1	Adaptor, Conversion, Gun, L&L	036-5311-00
1	Sound Adaptor Harness, L&L	036-5311-01
2	Decal, Left & Right, Side Cabinets, L&L	820-0084-00
1	Marquee Header, Locked and Loaded	830-0065-01
1	Monitor Underlay Card, Weapons	810-0063-00
1	Decal, Player 1 Start, Blue, Control Panel	406-0512-03
1	Decal, Player 2 Start, Red, Control Panel	406-0512-04
1	Control Panel Overlay, Red	406-0512-05

INSTALLATION INSTRUCTIONS

Locked and Loaded, is a two player video shooting game conversion kit. It is intended to be installed into an existing gun game cabinet and comes with all necessary components to make the converted game look and play like a new dedicated game.

When selecting a game to convert, make sure that the Power Supply, the Monitor and the Coin Acceptors are functional. There is nothing more frustrating than installing a conversion kit and having it not operate due to a faulty monitor or power supply. You should not expect the new logic PCB to be defective. It has been thoroughly tested and 'burned-in' at the factory.

It is mandatory that the cabinet be wired to conform with all National and Local electrical codes before the conversion is attempted. The primary power input section must have adequate noise filtering on the Ac line to prevent undesirable conducted radio frequency interference (RFI). "Adequate" is defined as a filter with both common mode and differential mode filtering and a minimum current capacity of 2.5 amperes.

The Federal Communications Commission (FCC) and certain regulatory agencies require that every video game be clearly labeled with the Name and Address of the Original Manufacturer, Date of Manufacture (or Serial Number), Power Requirements, Suitability for Indoor or Outdoor Use and the Model Number of the Unit. In addition, the FCC requires that, after conversion, the unit must be labeled with a suitable warning stating that radio frequency interference may result from use in a residential area.

STEP BY STEP CONVERSION INSTRUCTIONS FOR KIT (A): Model Number 1US95-01

PREPARE YOUR GAME FOR CONVERSION:

1. Make sure that power is completely off to the game (unplug Ac Cord).
Locate your isolation transformer between the Monitor and Ac input.
Not using an Isolation Transformer will damage the PCB !

CHECK YOUR KIT:

- 2 Open your new "Locked and Loaded" kit and familiarize yourself with the contents (complete list of materials is described in the Service Manual).

INSTALLING THE PCB:

4. Locate and Install your new **Locked and Loaded PCB**.
5. Plug in your old Jamma connector to PCB's edge connector.

CONNECTING THE SOUND HARNESS:

6. Locate your existing old sound harness and connect it to port CN5 of Locked and Loaded PCB. If the connector is different, use **Data East Sound Adaptor Harness 036-5311-01** included in your kit.

INSTALLING THE GUNS:

7. Use your old guns. Connect the end terminal of your old gun harness to connector CN9, located on the Locked and Loaded PCB. Please note that the **gun conversion adaptor** was already attached to CN9 at the factory.

CONNECTING THE DATA EAST TEST SWITCH :

8. Locate the **test switch with harness** (Part # 036-5311-03) in your Data East, "Locked and Loaded" kit. Locate your existing test switch and disconnect the wiring (grey / white and black wires). Your old test switch will be used as a service switch for your "Locked and Loaded" game. Mount your new test switch (Sliding type) to the service panel. Plug the red connectors of the new test switch harness into the connectors of your existing test switch wiring. Plug the pink connectors into your old test button. The opposite end of the violet wire should be plugged into position "R" of your JAMMA connector (see diagram on page 11 of your service manual).

POWER UP:

9. Double check every connection, make sure that everything is properly connected. Turn power ON, the game should function without any problems.

NOTE: In the event that the Ac fuse should blow, all power to the game will be lost. Check harnessing for proper connections and look for obvious damage to monitor, power supply and logic PCB set before replacing the fuse and applying power again.

STEP BY STEP CONVERSION INSTRUCTIONS FOR KIT (B): Model Number 1US95-02

PREPARE YOUR GAME FOR CONVERSION:

1. Make sure that power is completely off to the game (unplug Ac Cord).
Locate your isolation transformer between the Monitor and Ac input.
Not using an Isolation Transformer will damage the PCB !

CHECK YOUR KIT:

2. Open your new "Locked and Loaded" kit and familiarize yourself with the contents (complete list of materials is described in the Service Manual).

INSTALLING THE PCB:

4. Locate and install your new Locked and Loaded PCB in the game cabinet.

CONNECTING THE JAMMA CONNECTOR:

5. Install the new Jamma connector that is supplied with your kit.
6. Find **test switch with harness** (part # 036-5311-03) in your "Locked and Loaded" kit. Open the coin door and mount the test switch on the service panel, use switch only, discard test switch adaptor harness. The JAMMA connector diagram is shown on page 11 in the Locked and Loaded service manual.
7. Connect Start 1 and Start 2 wires to the push button switches, located under the control panel.
8. Connect Dc harness connector to the switching power supply (+5vdc and +12vdc).
9. Connect Ac harness to the marquee fluorescent light fixture.
10. Connect Ac harness to the display monitor.

CONNECTING THE SOUND HARNESS:

6. Locate your existing old sound harness and connect it to port CN5 of Locked and Loaded PCB. If the connector is different, use Data East **Sound Adaptor Harness** (036-5311-01) included in your kit.

INSTALLING THE GUNS:

7. Connect the two (2) gun end terminals to CN9, located on the Locked and Loaded PCB. Please note that the **gun conversion adaptor** was already attached to CN9 at the factory.

POWER UP:

Double check all harness connections. Turn power ON, the game should function without any problems.

NOTE: In the event that the Ac fuse should blow, all power to the game will be lost. Check all harnessing for proper connections and look for obvious damage to monitor, power supply and logic PCB set before replacing the fuse and applying power again.

OPERATOR OPTIONS:

The game allows for operator adjustable pricing, number of lives, difficulty, reload mode select (magazine or trigger switch), sound volume, etc.

These parameters may be changed by accessing the game software setup tables and make the appropriate selection by squeezing the left gun trigger.

To access the setup menu turn power ON, open the coin door and slide the setup switch to "ON" position.

To EXIT, from SETUP mode to GAME mode, slide the setup switch to "OFF" position.

The following menu will be displayed if SETUP IS selected (Slide Switch ON) :

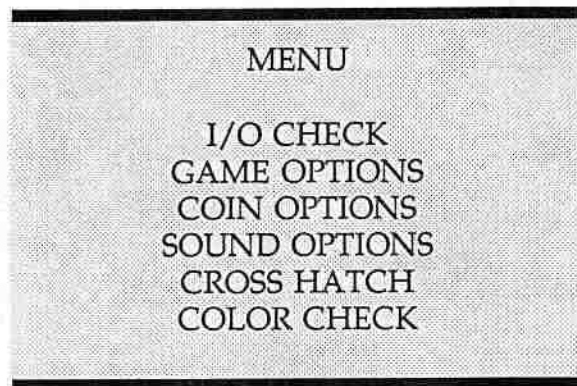

I/O CHECK - Check all of the input devices such as: Left and Right Gun trigger switch, Start 1 and Start 2 inputs and Service Switch.

GAME OPTIONS :

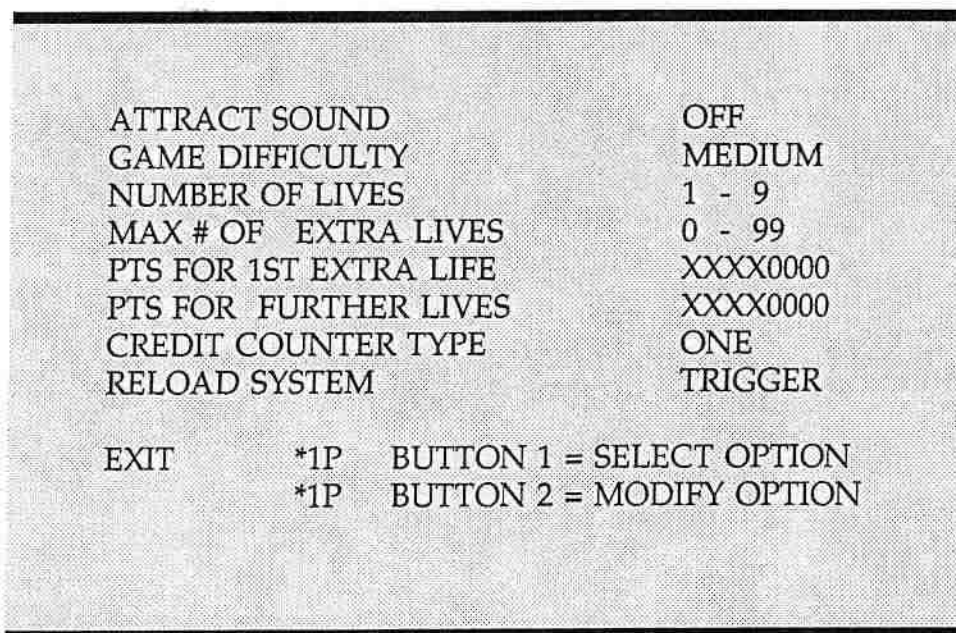

ATTRACT SOUND:	ON	OFF	
GAME DIFFICULTY	EASY	HARD	HARDEST
CREDIT COUNTER TYPE	ONE	DOUBLE	
RELOAD SYSTEM	TRIGGER	MAGAZINE	

MAX # OF EXTRA LIVES : Indicates the maximum number of extra lives a player may acquire during on game.

PTS. FOR 1ST EXTRA LIFE: Indicates the score the player must reach in order to acquire his/her first extra life.

PTS. FOR FURTHER LIVES: Indicates the number of points required (after the first extra life) for the player to acquire further lives.

RELOAD SYSTEM: Ammunition reload is done by pointing the gun away from the display monitor and pulling the gun trigger.
 From the GAME OPTION MENU, please select TRIGGER as RELOAD SYSTEM. **DO NOT SELECT MAGAZINE !!!!!.**
 Scan through the Game Option table and highlight the desired action by pressing the 1 player gun trigger (left), make changes by pressing the 2 player start button (right hand side on the control panel). Once the settings have been changed press the 1P Start button to confirm all new entries.

COIN OPTIONS :

COIN OPTIONS

GAME START TYPE
 NORMAL COIN CREDIT
 FREE PLAY
 COIN SETTING

MECH 1	1 COIN	1 CREDIT
MECH 2	2 COIN	1 CREDIT

EXIT

GAME START TYPE: There are two credit settings available, NORMAL CREDIT and 2 COIN CREDIT.

FREE PLAY: Free Play option can be set by changing the FREE PLAY icon from NO to YES.

COIN SETTINGS: This setting allows you to set the number of coins required for one credit. Select MECH 1 or MECH 2 by pulling the trigger of the 1P GUN.

SOUND OPTIONS:

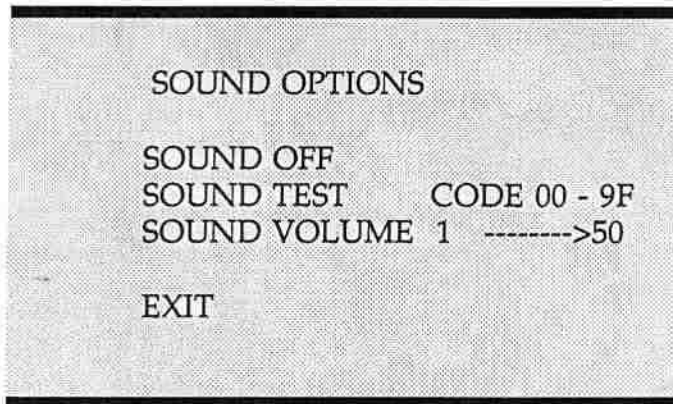

SOUND OFF - Used for switching sound ON or OFF

SOUND TEST- Used for testing sound effects outputs

SOUND VOLUME- Volume control, level 1(min) to 50(max)

CROSS HATCH PATTERN:

Use this pattern to adjust the video output to center of the monitor.

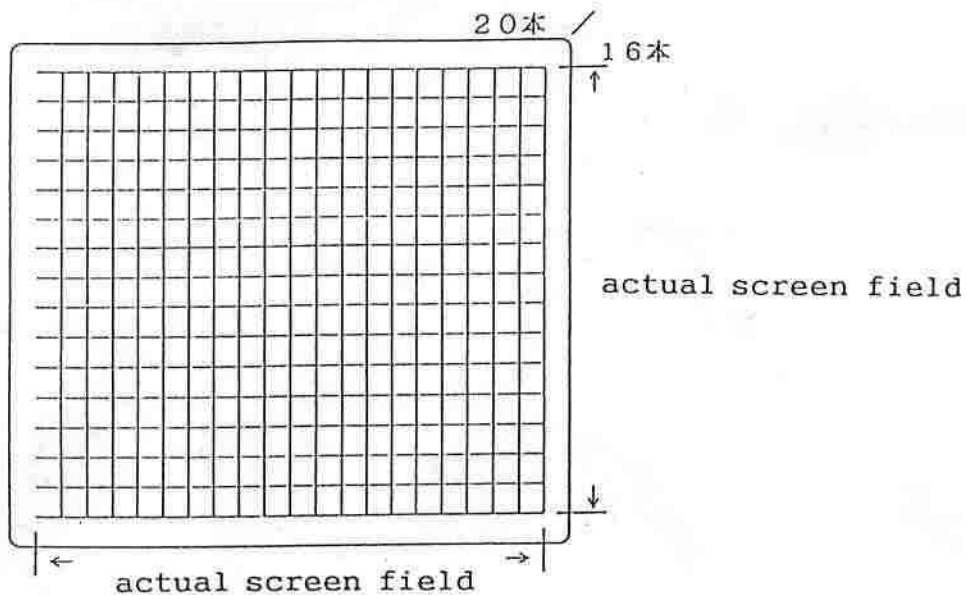

COLOR CHECK PATTERN:

Use this pattern to adjust the brightness and contrast of the color.

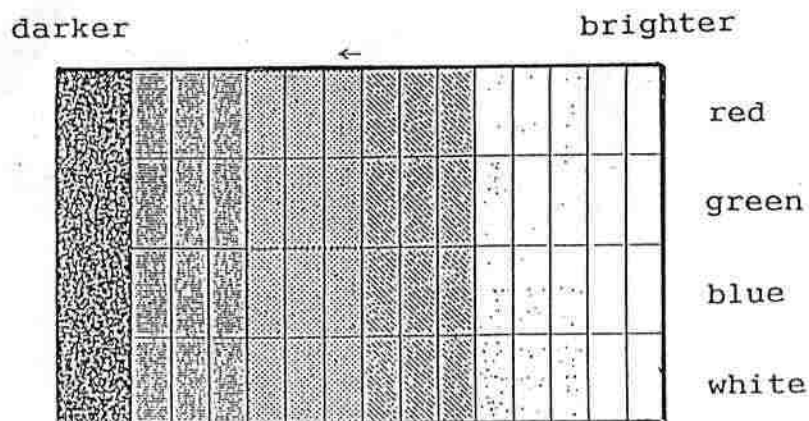

GUN AIM CHECK AND ADJUSTMENT IS NECESSARY WHEN:

- a). Gun aim is not accurate.
- b). If you are not able to start the game play by shooting at the game icon (You will hear the shooting sound, but no holes are pierced through the icon).

GUN AIM ADJUSTMENT INSTRUCTIONS:

- 1). Slide the test switch "ON" while holding the service switch DOWN
- 2). Shoot at the red target displayed on the left side of the screen, then point the gun away from the screen and pull the trigger. Press player 1 start button.
- 3). Shoot at the red target displayed on the right side of the screen, then point the gun away from the screen and pull the trigger. Press player 1 start button.
- 4). Shoot at the red target displayed on the top of the screen, then point the gun away from the screen and pull the trigger. Press player 1 start button.
- 5). Shoot at the red target displayed on the bottom of the screen, then point the gun away from the screen and pull the trigger. Press player 1 start button.
- 6). Shoot at the red target displayed on the center of the screen, then point the gun away from the screen and pull the trigger. Press player 1 start button.
- 7). Press the Player 2 start button to go to "Gun aim check screen". Shoot at the five red targets (top, bottom, left, right, center). Bullet marks will be displayed on the screen, allowing you to check the accuracy of the aim alignment. If you wish to return to the gun aim setting screen, press the Player 1 start button.
- 8). If gun aim alignment is satisfactory press the service switch and repeat the above procedure for the 2 Player gun.
- 9). After both guns have been correctly aligned switch the test switch to "OFF" position to return to normal game mode.

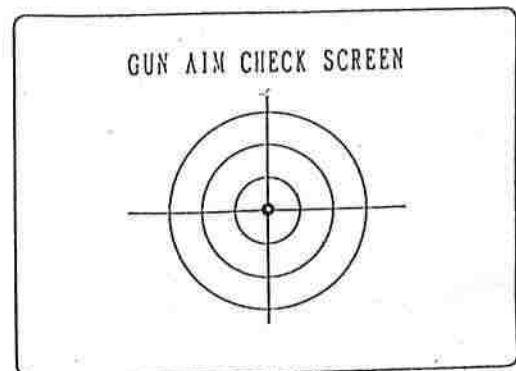
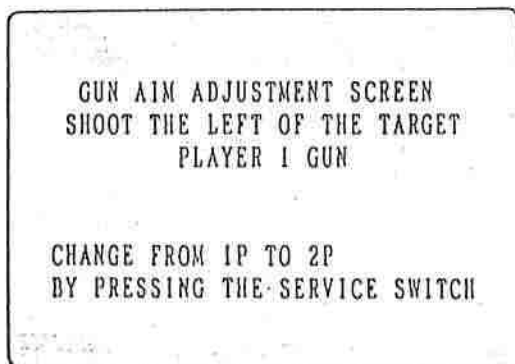

CN3 - JAMMA CONNECTOR

GND	A	1	GND
GND	B	2	GND
+5VDC	C	3	+5VDC
+5VDC	D	4	+5VDC
	E	5	
+12Vdc	F	6	+12Vdc
BLOCK	H	7	BLOCK
	J	8	COIN COUNTER 1
	K	9	
	L	10	
	M	11	
VIDEO GREEN	N	12	VIDEO RED
VIDEO SYNC	P	13	VIDEO BLUE
SERVICE SWITCH	R	14	VIDEO GND
	S	15	TEST SWITCH
	T	16	COIN SWITCH 1
START SWITCH 2	U	17	START SWITCH 1
	V	18	
	W	19	
	X	20	
	Y	21	
	Z	22	
	a	23	
	b	24	
	c	25	
	d	26	
GND	e	27	GND
GND	f	28	GND

GUN PCB

INSIDE THE ORANGE COLOR GUN.

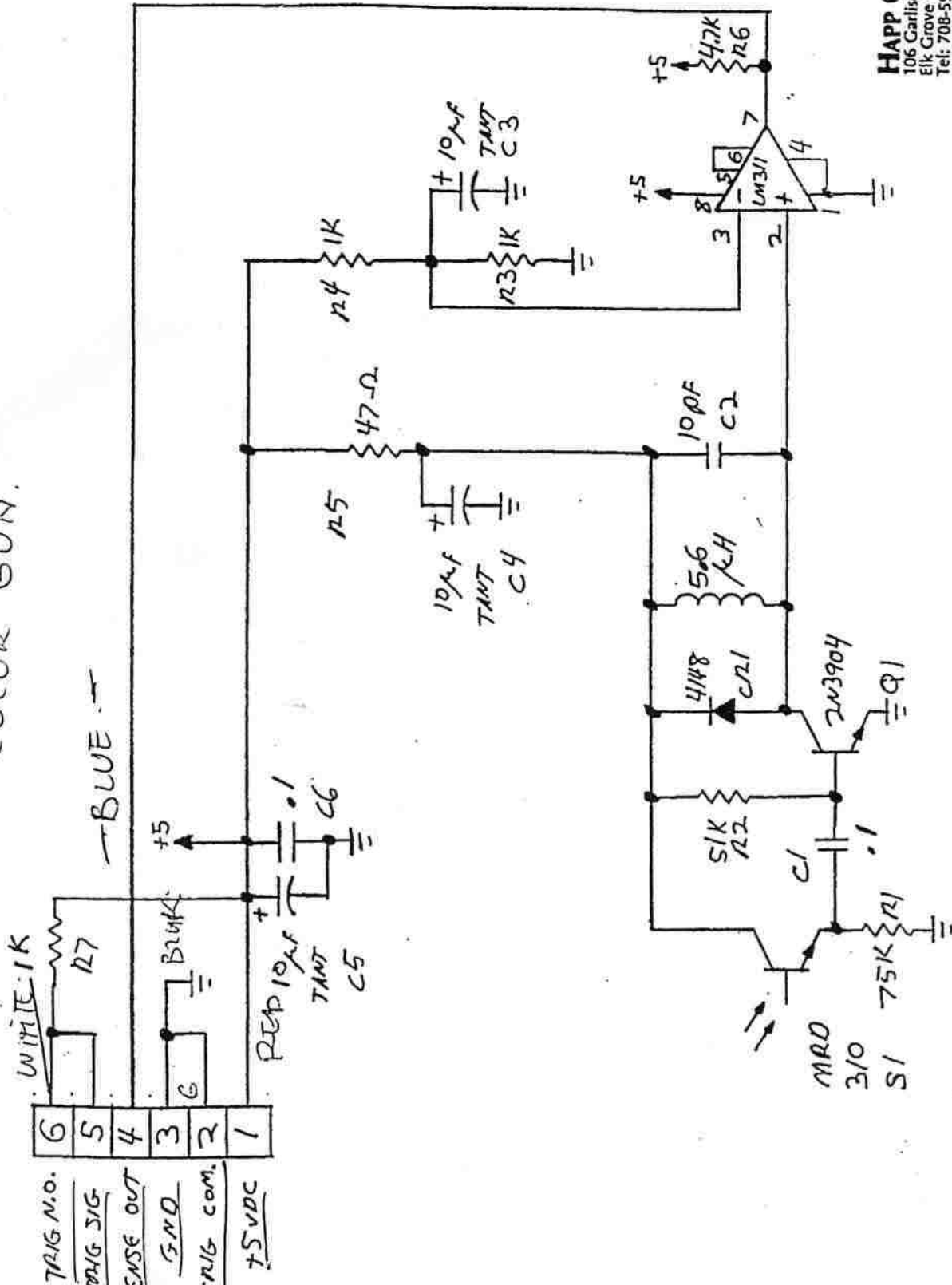

HAPP CONTROLS
 106 Garlich Drive
 Elk Grove Village, IL 60007
 Tel: 708-593-6130
 Made in U.S.A.

SCHEMATIC, 89G-0066-00
 OPTIC GUN PCB

HAPP CONTROLS, inc.

Manufacturer of Electronic Controls

106 Garlisch Drive • Elk Grove, IL 60007

Phone: 708-593-6130

Telex: 297249 CONTROLS US

Fax: 708-593-6137

>>> HAPP OPTIC GUN - #96-2100-17 <<<

The Happ Optic Gun is intended to be used on a video game to optically sense a small area of the screen and provide a synchronization signal via a trigger to the game hardware.

The player aims the gun to select a target on the screen and pulls the trigger when he wants to "shoot" the target. The game system determines if a valid target was selected when the trigger is pulled and reacts accordingly. The gun will operate with projection monitors, in bright or dim ambient light conditions and is sensitive to all crt colors, although it operates best when the screen is flashed white or cyan for one frame each time the trigger is pulled. Most optic gun games currently made will do this.

The gun is injection molded from orange ABS plastic and contains a sensor, pcb and lens to detect light from a crt screen. A gold contact switch is included to provide the trigger signal.

The gun is powered by +5 vdc. The optical output signal is a negative going pulse from a LM311 voltage comparator pulled up with a 4.7k resistor. This output is given at the horizontal frequency and is present whenever the gun is aimed at the screen. The trigger signal is a single negative going pulse pulled up with a 4.7k resistor and is active as long as the trigger is pulled. The harness has a four pin .100 center connector to connect to the game system with the following pinouts:

Pin 1 - +5vdc - red wire, Pin 2 - trigger signal - white wire,
Pin 3 - circuit ground - black wire, Pin 4 - optic signal - blue wire.

The gun is anchored to the game cabinet with a highly flexible 12 mm diameter, 1.2 meter long hydraulic hose. The hose can withstand twisting and pulling without damage and will protect the high-flex wire used to connect the gun to the game system. The hose is securely anchored to the gun and cabinet and cannot be twisted or pulled off. There is a strain relief boot on the hose as well as a special mounting bracket where it fastens to the cabinet.

1	2	3	4
関連番号	仕様, 名称		

GUN

CONVERSION ADAPTOR
PART# 036-5311-00

4 RED
3 YELLOW
2 BLUE
GREEN

AMERICAN LASER

RED
WHITE
BLACK
YELLOW

YONJAMI

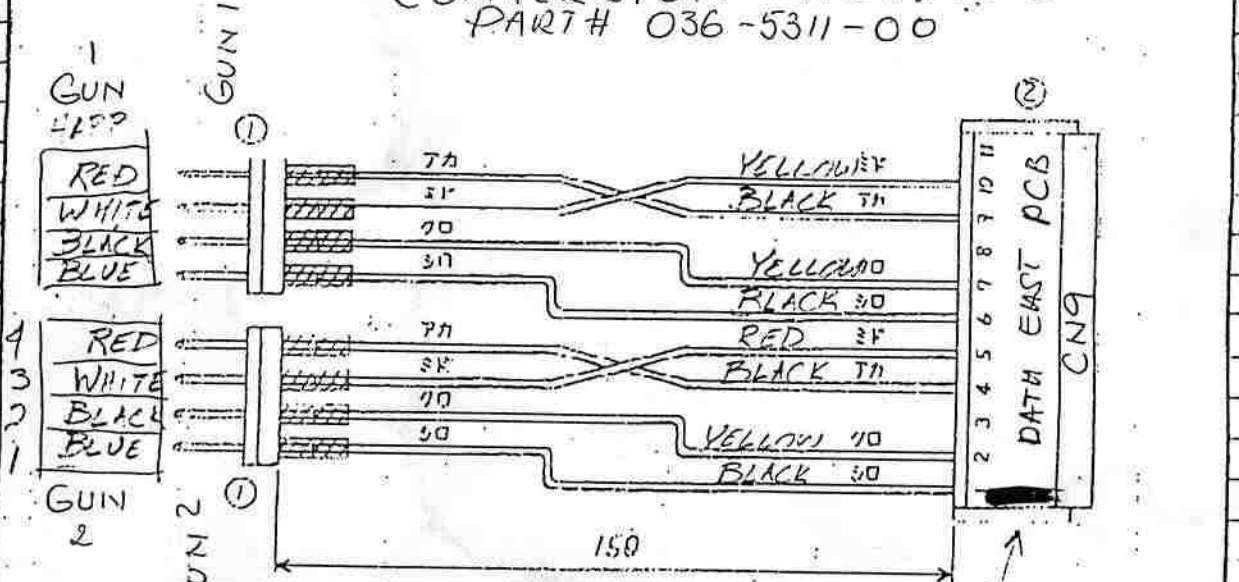

- ベース付ホスト (◎); B4P-SHF-1AA (JST) 7ヶ
- ハウジング (◎); H11P-SHF-AA (JST) 1ヶ
- コネクタ ; SHF-001T-088B (JST) 8ヶ
- ワイヤ ; AWG22 UL1007 -J-

※1234部は、ワイヤと端子を半田付加工した後、熱収縮チューブφ2.5-10mm
により、熱収縮加工を行う事。

SOUND ADAPTOR
PART# 036-5311-01

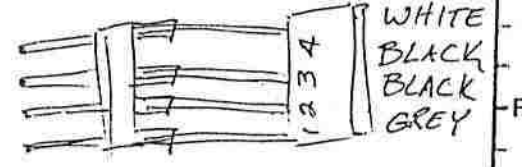

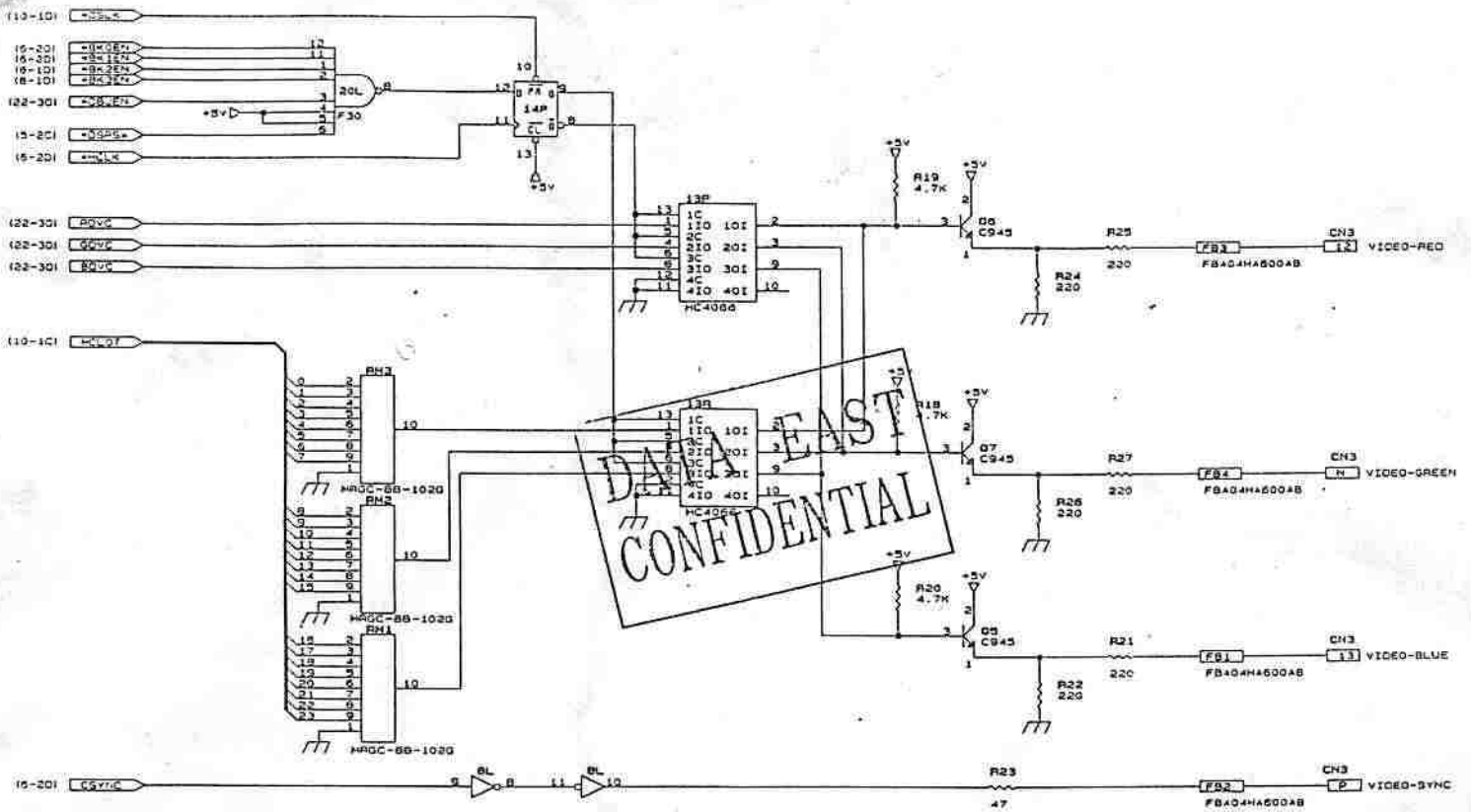

DATA EAST
CONFIDENTIAL

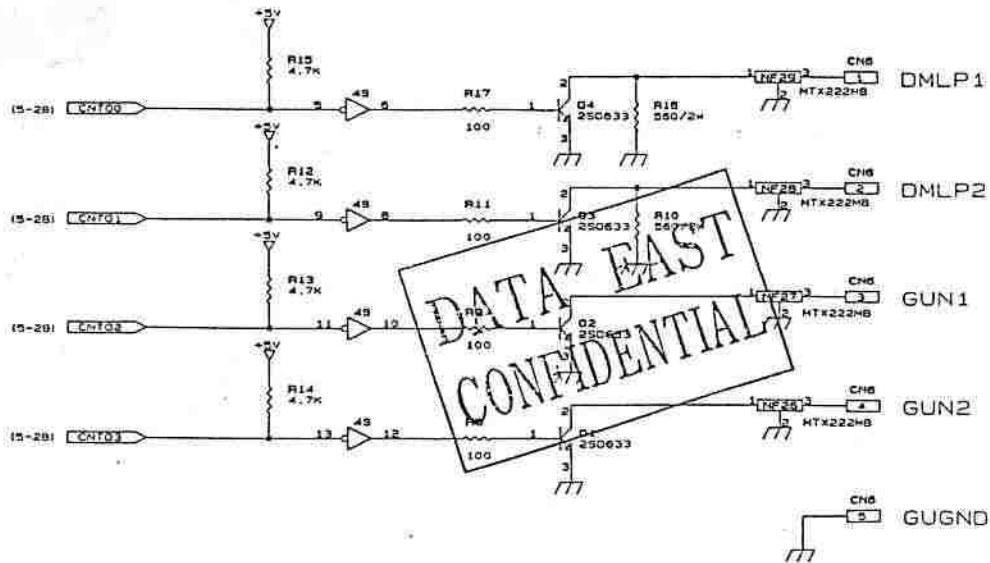
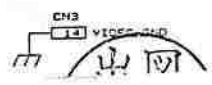

DATA EAST
CONFIDENTIAL

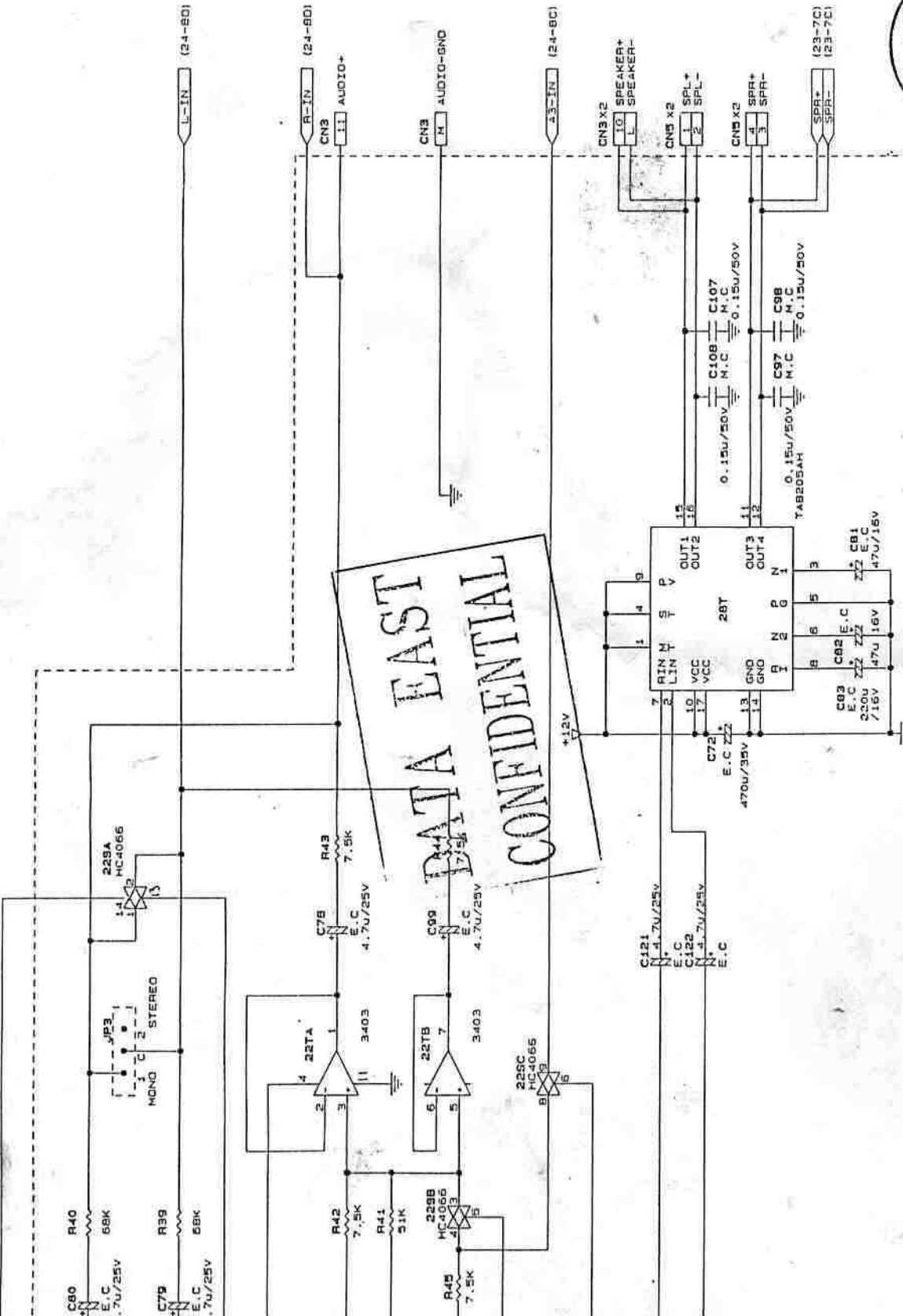

DATA EAST
CONFIDENTIAL



* Dash-Line_GND_Plane

Mark	Change	Date	Revised Place	Accounting	Check	NAME	SAMP
				K. Higashimura	山田	GUN-KAIZOU-M. SCH	
				'94.9.8	Change	S. NG	
				大木	1994.9.8	LK-10386	
							19
							24

ORATION

LOCKED AND LOADED CONVERSION KIT

